

J

J-Series

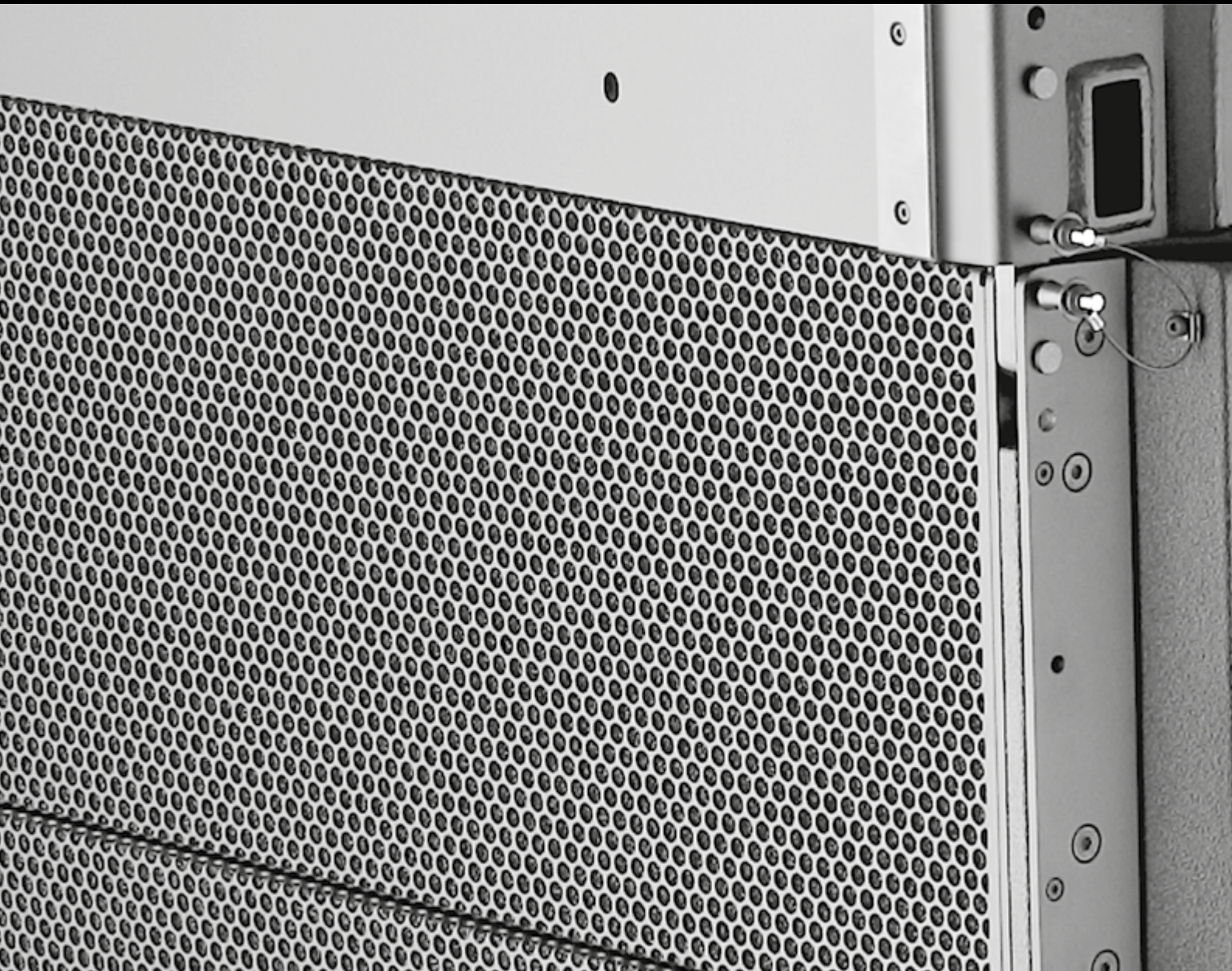

d&b
audiotechnik 

Contents



The d&b System reality	4
The J-Series	6
Certified Pre-Owned loudspeaker	10
The J8 and J12 loudspeakers	11
The J subwoofer	12
The J-INFRA subwoofer	13
The J-Series rigging system	14
The J-Series rigging examples	15
The d&b ArrayCalc simulation software	16
The d&b NoizCalc immission modelling software	18
The d&b R1 Remote control software	19
The d&b amplifiers	20
The controller setups and operation with d&b amplifiers	22
The J-Series frequency responses	23
The d&b amplifier output modes	24
The DS10 and DS20 Audio network bridges	25
The DS100 Signal Engine	25
The J-Series configuration examples	26
The J-Series cables and adapters	30
The J-Series product overview	34

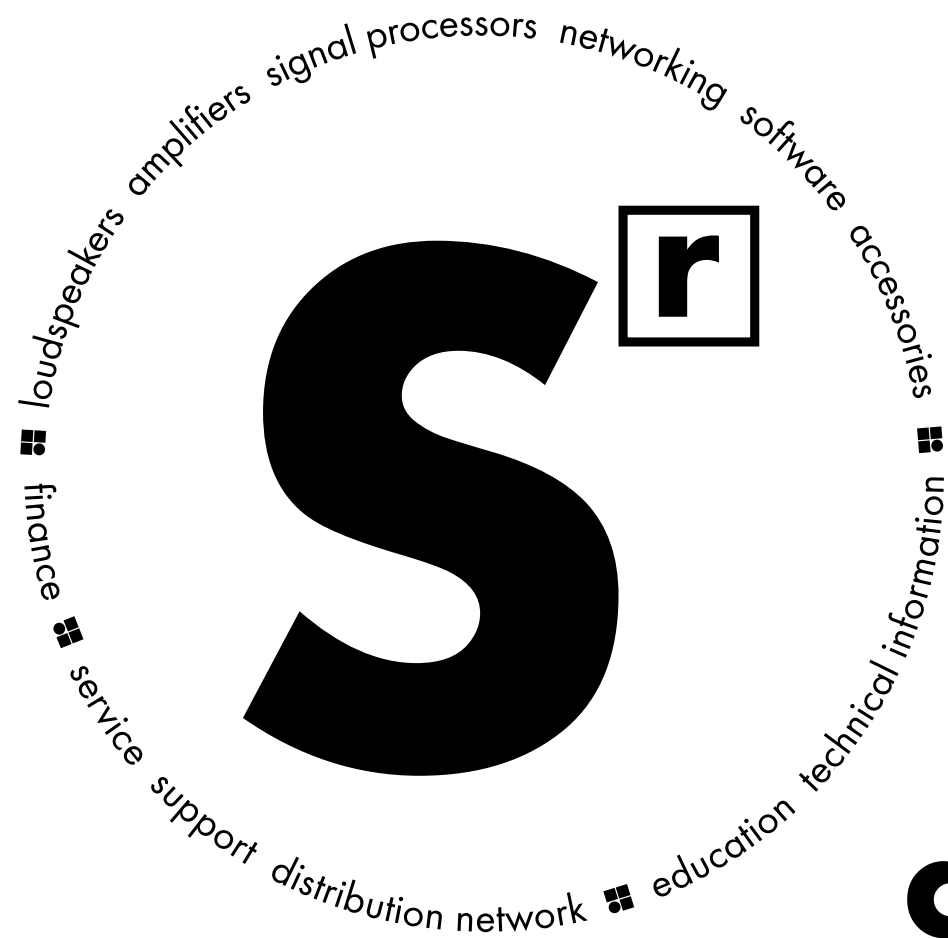

d&b System reality

As the name implies a d&b audiotechnik system is not just a loudspeaker. Nor is it merely a sum of the components: loudspeakers, amplifiers, signal processors, networking, software and accessories. Right from the outset the d&b audiotechnik approach was to build integrated sound reinforcement systems

that actually are more than the combination of parts: an entirety where each fits all. Every element is tightly specified, precisely aligned and carefully matched to achieve maximum efficiency. For ease of use, all the user-definable parameters are incorporated, allowing the possibility of adjustment, either

directly, via remote control surfaces, or integrated within wider networks. Neutral sound characteristics leave the user all the freedom needed to realize whatever the brief. At the same time d&b offers finance, service and support, a knowledgeable distribution network, education and training as well as technical

information, so the same optimal acoustic result is achieved consistently by every system anywhere, at any time. In reality: the d&b System reality.



The sonic performance of the established **J-Series** large-format system is suitable for any event style or genre. With transparent, detailed audio performance, extraordinarily smooth and even frequency response, dynamic bandwidth, as well as high power and headroom capability, this touring industry

standard line array system is a large scale, but still flexible, sound reinforcement solution. This high-fidelity Series comprises J8 and J12 loudspeakers providing 80° and 120° horizontal dispersion respectively. These line array modules maintain constant directivity control down to low frequencies, while the J-SUB and the J-INFRA

extend the frequency response of this powerhouse system even further. With the d&b Certified Pre-Owned scheme the J-Series continues to tour internationally, delivering the same renowned premium sound quality with the added benefit of a drastically reduced carbon footprint through the process of remanufacturing.

Beyond a technical renewal, a Certified Pre-Owned system includes new amplification and electronics, as well as all the same accessories, service, finance and support advantages as brand new systems.

The J-Series

The **J8** and **J12** loudspeakers are acoustically matched and constructed to be mechanically compatible sharing the same vertical directivity, size, footprint, weight, rigging and driver complement. The 3-way design featuring two 12" LF drivers, one hornloaded 10" MF driver and two 1.4" exit HF compression drivers with 3" voicecoils mounted to a dedicated waveshaping device. The symmetrical dipolar arrangement of the neodymium LF drivers around the centrally mounted coaxial MF and HF components allows a smooth overlap of the adjacent frequency bands in the crossover design. The 80° horizontal constant directivity dispersion pattern of the J8 is maintained down to 250 Hz and its high output capability can cover a distance range of over 100 m (330 ft), depending on the climatic conditions. The J12 has a wider horizontal dispersion pattern of 120° maintained down to 250 Hz.



J8, J12 loudspeaker

The **J-SUB** shares the same width as the J8 and J12 loudspeakers and is equipped with compatible flying fittings. The bass-reflex design uses three 18" high excursion drivers, one of which radiates to the rear to produce cardioid or hypercardioid subwoofer performance to avoid unwanted energy behind the system.



J subwoofer

The **J-INFRA** extends the bandwidth of a J-Series system down to 27 Hz as well as increasing its headroom and is intended only for ground stacked setups. The bass-reflex design uses three 21" high excursion drivers, one of which radiates to the rear to produce cardioid or hypercardioid subwoofer performance to avoid unwanted energy behind the system.



J-INFRA subwoofer

Both the J-SUB and J-INFRA can be deployed in conventional left and right ground stacked setups as well as in distributed sub arrays to achieve an even venue specific coverage pattern.

All J-Series loudspeakers are finished with a PCP (Polyurea Cabinet Protection) coating that provides resistance for mobile systems to the adverse effects on cabinets in changing ambient outdoor conditions.

The d&b software offering aides the entire system setup process. The **d&b ArrayCalc simulation software** allows the virtual optimization of loudspeaker line arrays, point source and column loudspeakers as well as subwoofers and their adjustment to venue conditions. The **d&b NoizCalc immission modelling software** uses international standards to model noise immission from one or more d&b loudspeaker systems. NoizCalc takes data from ArrayCalc and calculates the sound propagation towards the far field. The complete system configuration simulated in ArrayCalc is assimilated by the **d&b R1 Remote control**

software into an intuitive graphical user interface to manage the amplifiers, and loudspeakers, from anywhere in the venue.

The **R90 touchscreen remote control** provides quick, reliable, and effortless operation of day-to-day functions of a preconfigured d&b system, without needing expert level knowledge of audio.



R90 Touchscreen remote control

A wide range of tools and data files are available to support the planning process using external tools.

d&b amplifiers are specifically designed for use with d&b loudspeakers, and are at the heart of the d&b system approach. These devices contain extensive Digital Signal Processing capabilities to provide comprehensive loudspeaker management and specific switchable filter functions to precisely target the system response for a wide variety of applications. The four channel **D80** amplifier is intended for both mobile and installation applications requiring the highest Sound Pressure Levels. The installation specific four channel **30D** amplifier is intended for permanent integration within venues which require medium to high Sound Pressure Levels. These amplifiers all provide extensive user-definable equalization containing two 16-band equalizers with parametric, notch, shelving and asymmetric filters as well as delay capabilities of up to 10 seconds.



D80 amplifier



30D amplifier

The d&b Audio network bridges interface between audio transport networks and AES3 digital audio signals while also providing distribution of Ethernet control data. The **DS10** supports Dante networks, while the **DS20** is used for the open standards-based Milan protocol.



DS10 Audio network bridge



DS20 Audio network bridge

The **DS100 Signal Engine** is based on a specialized rack mount 3 RU audio processor with Audinate Dante networking. It provides a 64 x 64 audio matrix with level and delay adjustments at all cross points. Additional software modules provide dynamic source positioning and emulated acoustics functions.



DS100 Signal Engine

Certified Pre-Owned loudspeaker

The J8 and J12 loudspeakers

d&b Remanufacturing

d&b Remanufacturing is a no compromise approach to extending the life of d&b systems, for the benefit of customers and the environment. Before a change of ownership, CPO J-Series systems are dismantled and inspected by d&b technicians to ensure that they meet original d&b manufacturing quality standards. These tests and inspections include the following:

Exterior check

Cabinets, including handles and all metal components, are cleaned and inspected to ensure they are free of cracks. Where necessary, these parts are repaired or replaced. All foam and seals are replaced, and the exterior is repainted with the original d&b top coat.

Mechanical check

Safety-critical components including pins, rigging, links, wheels, latches, frames, rigging and chains are all inspected for damage, tested, and replaced where necessary. Each component must meet the same standards as new systems. All chains are tested and verified by an external company.

Acoustic check

A CPO system goes through the same frequency and impedance checks as new systems. Technical components including drivers and crossovers are tested and replaced if necessary. Loudspeakers are also subject to a listening test, for those performance qualities that can only be evaluated by listening to a sine sweep.

Every CPO J-Series System comes with new 6 x D80 Touring rack assemblies CDA, with MC24 cabling standard and breakouts to NLT4. The package can be expanded to include ArrayProcessing, however this must be requested. All remanufactured components come with a two-year warranty while new parts come with a five-year warranty.



J8 before refurbishment process



J8 after refurbishment process



J-Series CPO package

J8 and J12 loudspeakers

The J8 and J12 loudspeakers are line array modules designed for long throw applications. Its 3-way design uses an active crossover between the low and mid and a passive crossover between the mid and high frequencies. J8 and J12 are completely symmetrical horizontally with two 12" neodymium low frequency drivers placed to the outsides in a dipolar arrangement. Its hornloaded coaxial mid and high frequency section is mounted in the centre of the loudspeaker. The mid frequency horn uses a 10" driver, while the high frequency section consists of two 1.4" exit HF compression drivers with 3" voicecoils mounted to a dedicated waveshaping device. The cylindrical wave segments produced couple coherently in the vertical plane. This results in an exceptional 120° horizontal constant directivity dispersion control nominally being maintained down to 250 Hz.

The mechanical and acoustical design enables flown vertical columns of up to twenty-four loudspeakers to be suspended using vertical splay angles between them of 0° to 7° with a 1° resolution. The J8 and J12 are acoustically and mechanically compatible to each other. The J8 and J12 are acoustically and mechanically compatible to each other. A mix of J8 and J12 can be used within a column, and/or combined with J-SUBs. The cabinets is constructed from marine plywood and has an impact and weather protected PCP (Polyurea Cabinet Protection) finish. The front of the loudspeaker cabinet is protected by a rigid metal grill and the side and rear panels incorporate four handles.

System data J8 · J12

Frequency response (-5 dB standard) 48 Hz - 17 kHz
 Frequency response (-5 dB CUT mode)..... 85 Hz - 17 kHz
 Max. sound pressure (1 m, free field)¹
 with 30D 145 · 143 dB
 with D80 145 · 143 dB

Loudspeaker data

Nominal impedance LF/MHF 6/12 ohms
 Power handling capacity LF (RMS/peak 10 msec) 500/2000 W
 Power handling capacity MHF (RMS/peak 10 msec) 200/800 W
 Nominal dispersion angle (horizontal) 80 · 120°
 Splay angle settings 0 - 7° (1° increment)
 Components 2 x 12" driver/1 x 10" driver
 2 x 1.4" exit compression driver
 passive crossover network
 Connections 2 x NLT4 F/M
 optional 2 x EP5 or 2 x NL8
 Weight 60 kg (132 lb)

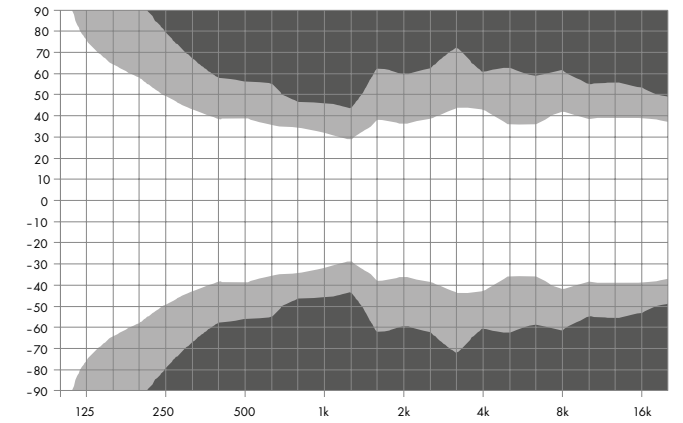

J8 horizontal dispersion characteristics²

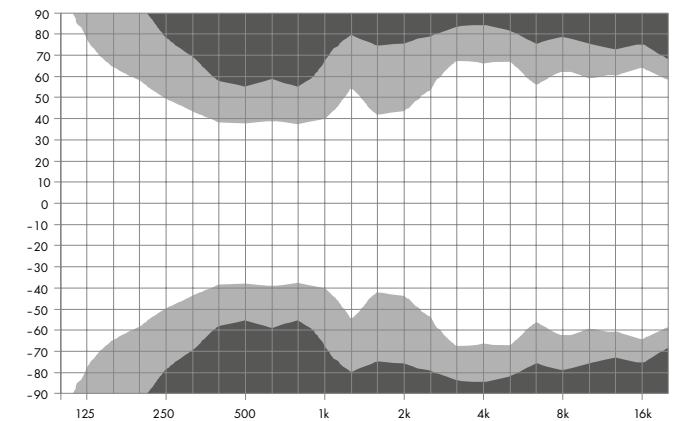

J12 horizontal dispersion characteristics²

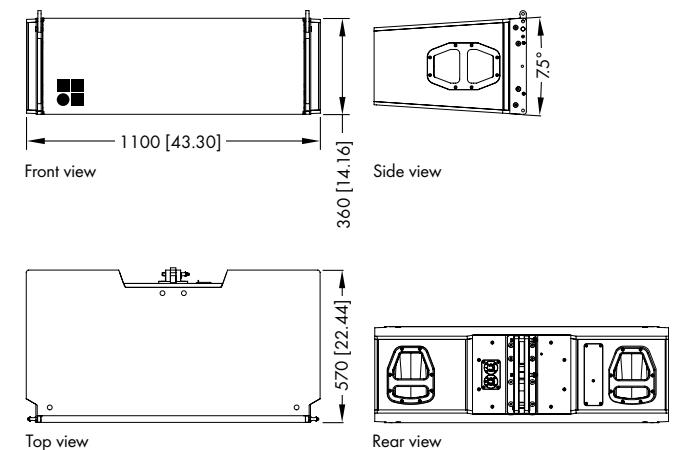

J8 and J12 cabinet dimensions in mm [inch]



¹ Broadband measurement, pink noise, crest factor 4, peak measurement, linear weighting
² Dispersion angle vs frequency plotted using lines of equal sound pressure (isobars) at -6 dB and -12 dB

The J subwoofer

J subwoofer

The J-SUB is the subwoofer for the J-Series. It is an actively driven 2-way bass-reflex design housing three long excursion neodymium 18" drivers, two drivers face to the front and one driver to the rear. The cardioid dispersion pattern resulting from this arrangement avoids unwanted energy behind the system that greatly reduces the excitation of the reverberant field at low frequencies and provides the greatest accuracy of low frequency reproduction.

The J subwoofer can be used to supplement J8 and J12 loudspeakers in various combinations, ground stacked or flown, either integrated on top of a J8/J12 array or as a separate column. Cabinets are mechanically connected using the rigging links on both sides of the cabinet front, and with a central rigging link at the rear of the cabinet.

The J-SUB cabinet is constructed from marine plywood and has an impact and weather protected PCP (Polyurea Cabinet Protection) finish. The front and rear of the loudspeaker cabinet are protected by a rigid metal grill and the side panels incorporate eight handles. Four 100 mm wheels are mounted at the rear.

System data

Frequency response (-5 dB standard)	32 - 100 Hz
Frequency response (-5 dB INFRA mode)	32 - 70 Hz
Max. sound pressure (1 m, free field) ¹	
with 30D	138 dB
with D80	139 dB

Loudspeaker data

Nominal impedance front/rear	4/8 ohms
Power handling capacity (RMS/peak 10 msec)	
Front	800/3200 W
Rear	400/1600 W
Components	3 x 18" driver
Connections	1 x NLT4 F
.....	optional 1 x EP5 or 1 x NL8
Weight	106 kg (234 lb)

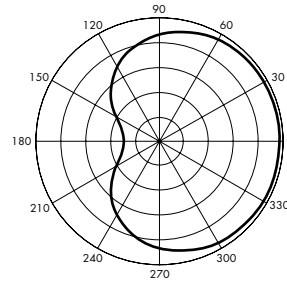

Standard Cardioid polar pattern

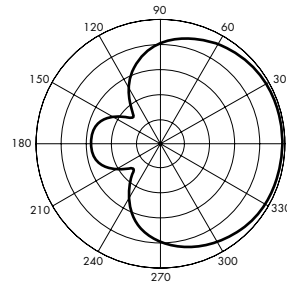

Hypercardioid polar pattern

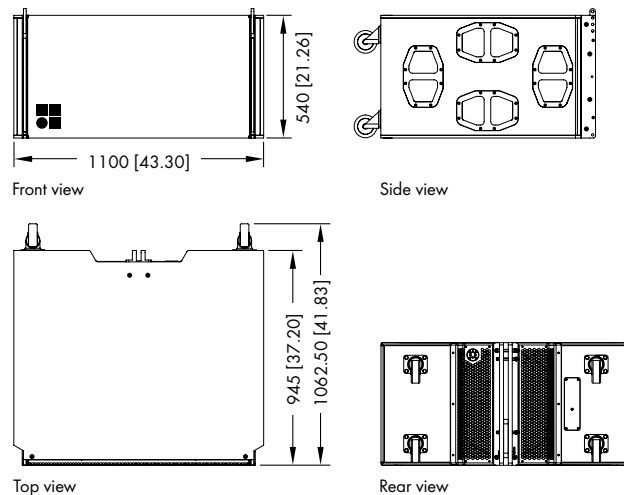

J-SUB cabinet dimensions in mm [inch]

The J-INFRA subwoofer

J-INFRA subwoofer

The J-INFRA is the INFRA subwoofer for the J-Series. It is an actively driven 2-way bass-reflex design and extends the frequency response of a J-Series system down to 27 Hz. It has two bass-reflex chambers containing three 21" drivers, two facing forward and one facing backwards. The cardioid dispersion pattern resulting from this arrangement avoids unwanted energy behind the system that greatly reduces the excitation of the reverberant field at low frequencies and provides the highest accuracy of low frequency reproduction.

The J-INFRA can only be used in ground stacked configurations in conventional left/right setups as well as arranged in a subwoofer array.

The J-INFRA cabinet is constructed from marine plywood and has an impact and weather protected PCP (Polyurea Cabinet Protection) finish. The front and rear of the loudspeaker cabinet are protected by a rigid metal grill and the side panels incorporate eight handles. Four 100 mm wheels are mounted at the rear.

System data

Frequency response (-5 dB standard)	27 - 60 Hz
Frequency response (-5 dB 70 Hz mode)	27 - 70 Hz
Max. sound pressure (single cabinet, 1 m, free field) ¹	
with 30D	141 dB
with D80	144 dB

Loudspeaker data

Nominal impedance front/rear	3/6 ohms
Power handling capacity (RMS/peak 10 msec)	
Front	800/3200 W
Rear	400/1600 W
Components	3 x 21" driver
Connections	1 x NLT4 F
.....	optional 1 x EP5 or 1 x NL8
Weight	152 kg (335 lb)

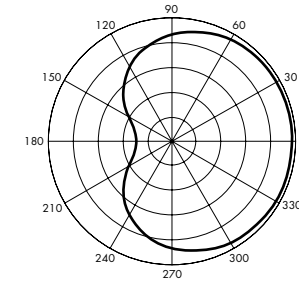

Standard Cardioid polar pattern

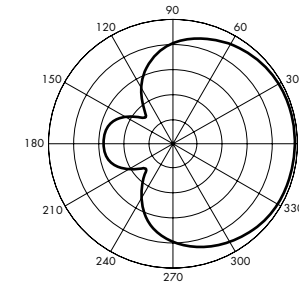

Hypercardioid polar pattern

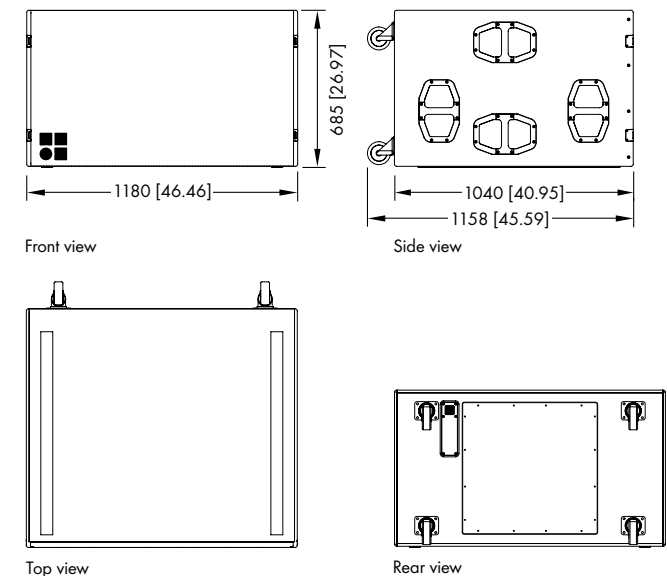

J-INFRA cabinet dimensions in mm [inch]

The J-Series rigging system

Safety approval

d&b loudspeakers and accessories are designed for setup and use within situations requiring compliance with the provisions and directives of the DGUV regulation 17 (formerly BGV C1).

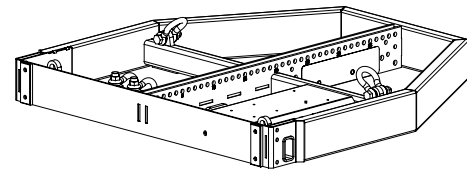

**Z5300
J Flying frame**
For twenty-four J8/J12 loudspeakers
or fourteen J subwoofers maximum

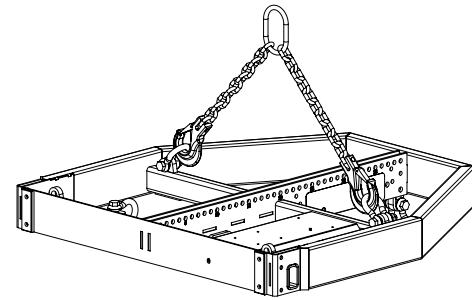

Z5300 J Flying frame
supplied with
Z5303 J Safety chainset
2 x J Load adapter
2 x J Front link
2 x Locking pinset 10 mm
1 x Locking pinset 11 mm
1 x Mounting plate for SSE® ProSight or
Rieker® inclinometers



**Z5303
J Safety chainset**

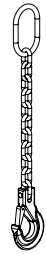

**Z5305
J Hoist connector chain**

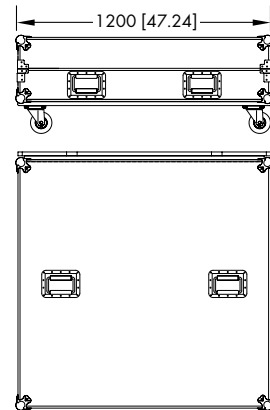

E7441 Touring case 1 x J Flying frame

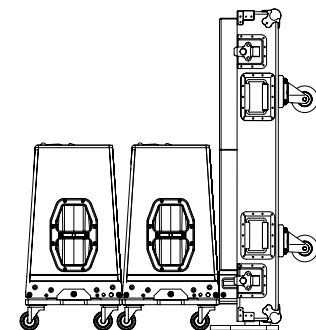
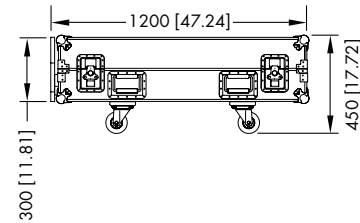

**J-Series rigging with
E7441 Touring case**

The J-Series rigging examples

These rigging examples are for illustration only. For further information please refer to the TI 385 d&b Line array design and J-Series Rigging manual, which are available for download at www.dbaudio.com.

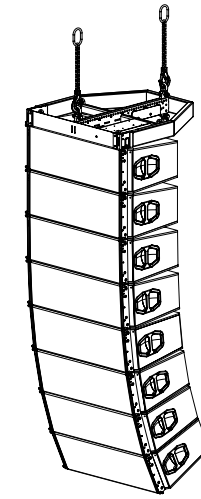

**J8/J12 array with
Z5300 J Flying frame
2 x Z5305 J Hoist connector chain**

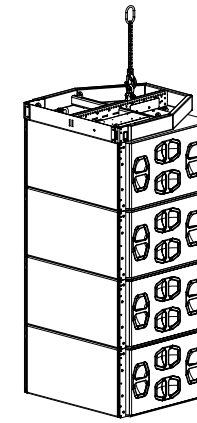

**J-SUB array with
Z5300 J Flying frame
Z5305 J Hoist connector chain**

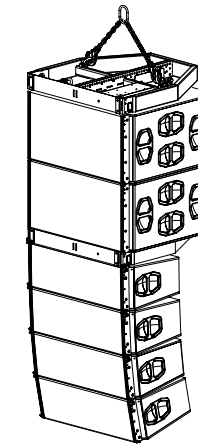

**J-Series mixed array with
2 x Z5300 J Flying frame
Z5303 J Safety chainset**

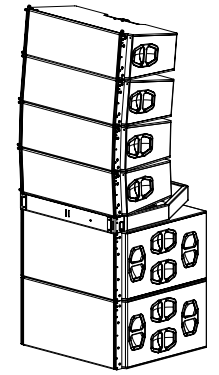

**J-Series ground stack with
Z5300 J Flying frame**

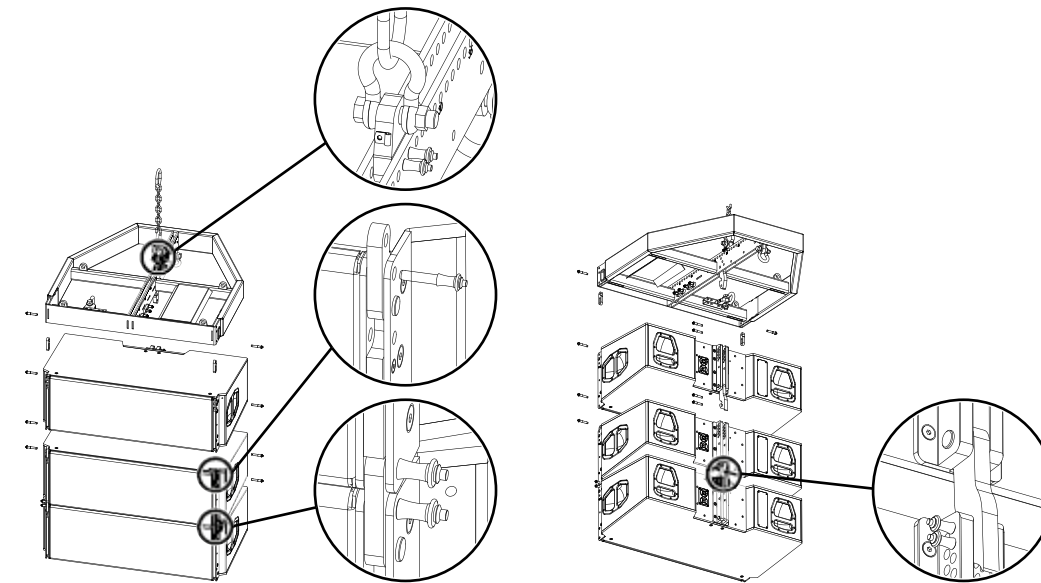

J-Series rigging system

The d&b ArrayCalc simulation software

The d&b ArrayCalc simulation software is the prediction tool for d&b line arrays, column and point source loudspeakers as well as subwoofers. This is a comprehensive toolbox for all tasks associated with acoustic design, performance prediction, alignment, rigging and safety parameters. For safety reasons d&b line arrays must be designed using the d&b ArrayCalc simulation software. ArrayCalc is available as a native stand-alone application for both Microsoft Windows¹ (Win7 64-bit or later) and Mac OS X² (10.12 or later) operating systems. In combination with the d&b Remote Network, this can significantly reduce setup and tuning time in mobile applications and allows for precise simulations when planning installations. Listening planes can be defined in the venue tab, creating a three dimensional representation of any audience area in a given venue. This can also include balconies, side stalls, arenas, in the round scenarios or festivals. Special functions assist in obtaining accurate dimensions with laser distance finders and inclinometers.

Simulation

Up to forty flown arrays or subwoofer columns can be defined in a project file as single hangs or in pairs. A selection of d&b point source loudspeakers can also be fully integrated as well as a ground stacked SUB array consisting of up to eighty positions. All can be freely positioned according to their intended application, for example as main hang, outfill, nearfill or delay. Position, orientation, aiming and coverage details are displayed. Level over distance is calculated for each source with high resolution in real time, for either band limited or broadband input signals. The comprehensive simulation precisely models the actual performance of the system, taking into account input level, all system configuration options (such as CUT, CPL, HFC or INFRA), limiter headroom and air absorption. Acoustic obstacles, such as video screens, can be added to a model. Acoustic shadowing, whether by these obstacles, or a balcony overhang, is taken into consideration. The load status of all array rigging components is calculated accurately and displayed to determine whether a given array is within the load tolerance. Subwoofer array design is assisted by coverage and polar plot prediction. A specialized algorithm allows the user to specify subwoofer positions and a coverage angle, which is then converted into appropriate delay settings that result in the desired dispersion. The alignment tab enables different sources to be time aligned to one another, as well as showing arrival times and Sound Pressure Levels at a definable reference point on one of the audience areas. For alignment of the flown system with the ground stacked SUB array, the phase response of both the SUB array and a flown source is calculated at a definable reference point.

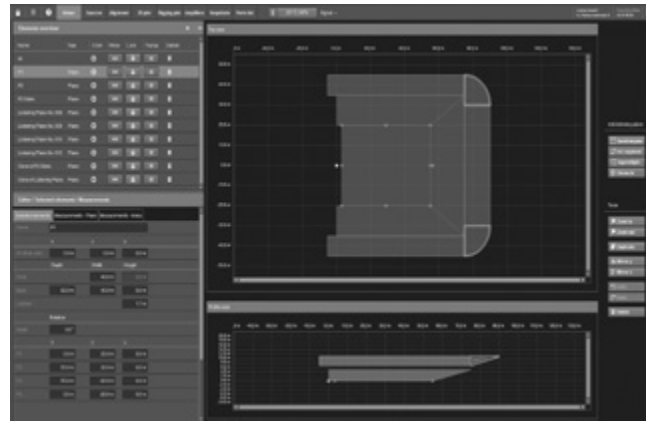

Venue

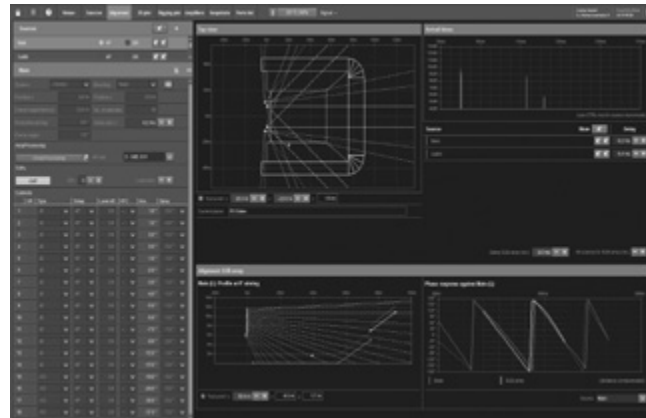

Alignment

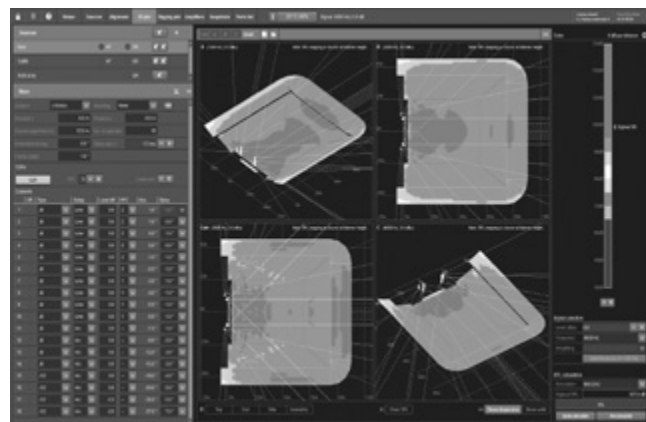

3D Plot quad

Both simulations reflect changes in delay time to the single sources in real time. The d&b ArrayCalc simulation software is available at www.dbaudio.com, along with further information and video tutorials.

Prediction

The level distribution resulting from the interaction of all active sources can be mapped onto the audience areas in a three-dimensional view, which can also be zoomed, rotated and exported as a graphics file. EASE and DXF data export capabilities are also available. A rigging plot with all necessary coordinates, dimensions and weights of arrays is generated for export and printing and a parts list, detailing all components required. The d&b ArrayCalc Viewer app presents this key information for positioning and flying a d&b audiotechnik loudspeaker system on a mobile device. Once the system has been designed, calculated and optimized, all relevant project information can be shared via email, AirDrop, or downloaded onto any iOS or Android device.

ArrayProcessing

The optional ArrayProcessing function applies powerful filter algorithms to optimize the tonal (spectral) and level (spatial) performance of a line array column over the audience area defined by its mechanical vertical coverage angle. Within the d&b ArrayCalc simulation software, spectral and level performance targets over the listening areas can be defined while specific level drops or offsets can be applied to certain areas, to assign reduced level zones. ArrayProcessing applies a combination of FIR and IIR filters to each individual cabinet in an array to achieve the targeted performance, with an additional latency of only 5.9 ms. This significantly improves the linearity of the response over distance as well as seamlessly correcting for air absorption. In addition, ArrayProcessing employs the same frequency response targets for all d&b line arrays, to ensure all systems share a common tonality. This provides consistent sonic results regardless of array length or splay settings. The resulting coverage is enhanced with spectral consistency and defined level distribution, achieving more linear dispersion and total system directivity to cover longer distances or steep listening areas effectively.

R1 Remote Control Software

R1 uses the same project file created by ArrayCalc and generates an intuitive graphical user interface including complete details of the simulated system, loudspeakers, amplifiers, remote IDs, groups, ArrayProcessing data and all configuration information. This workflow removes the need to manually transfer data from one software program to the other.

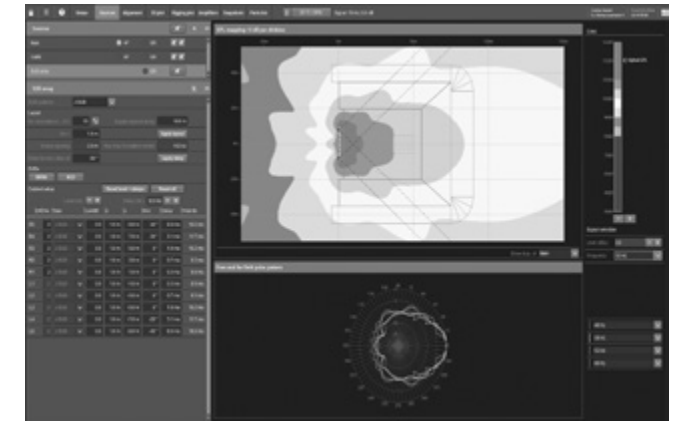

Sources, SUB array

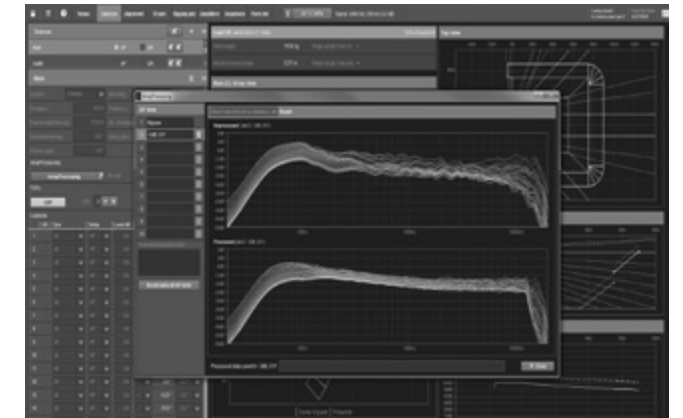

ArrayProcessing

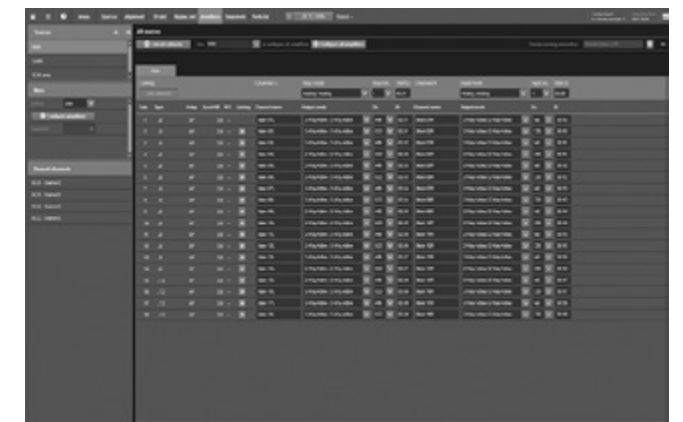

Amplifiers

¹ Microsoft Windows is a registered trademark or trademark of Microsoft Corporation in the United States and/or other countries

² Mac OS X is a trademark of Apple Inc., registered in the U.S. and other countries

The d&b NoizCalc immission modelling software

The d&b software uses international standards to model the far field noise immission from multiple complex and coherently emitting sources such as line arrays and subwoofer arrays. More and more, gaining permission and licenses to stage live open air events requires an official statement with a prediction of how noise could impact on the surrounding area. NoizCalc takes all complex loudspeaker data and a reference point from the d&b ArrayCalc simulation software and calculates the sound propagation and relative attenuation values towards the far field for a certain scenario with particular meteorological conditions for one or more d&b loudspeaker systems.

A 3D terrain map imported from Google Maps or Street View displays the calculated immission on the areas surrounding the audience listening zones. This visual representation shows the actual system performance in the far field, enabling users to optimize for listeners while satisfying local noise restrictions and offsite regulations.

To ensure reliable results, NoizCalc includes all complex data concerning the addition and subtraction of sound waves, including phase information to describe the combination and interaction effects within a loudspeaker system consisting of multiple line arrays, subwoofer arrays and delay systems.

NoizCalc models immissions in the far field according to the internationally accepted ISO 9613-2 or Nord2000 calculation standards. Ground characteristics can be set depending on the absorbency or reflectivity of surfaces, while areas with volume attenuating properties can be defined. Buildings can be included, and the maximum reflection order option adjusts how many reflections are calculated. Parameters for humidity, air pressure and temperature ensure that the correct air absorption figures are accounted. The ISO 9613-2 standard requires limited meteorological information and assumes a worst-case scenario. The more sophisticated propagation model, Nord2000 enables a more precise handling of meteorological conditions allowing the user to model with prevailing wind information. The d&b NoizCalc immission modelling software is available at www.dbaudio.com for registered download, along with further information and video tutorials. It was developed in collaboration with SoundPLAN, a specialist software developer for environmental noise prediction.

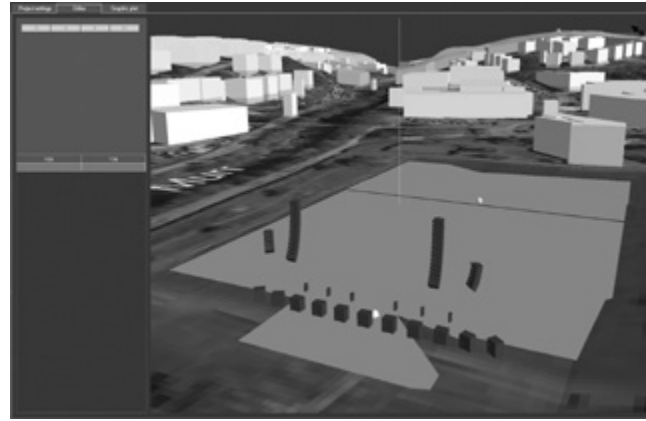

Editor



Graphic plot

The d&b R1 Remote control software

The remote control capability of the d&b Remote Network enables central control and monitoring of a complete d&b loudspeaker system from anywhere in the network, be it from a computer in the control room, at the mix position, or on a wireless tablet in the auditorium. This central access to all functions throughout the d&b Remote Network unlocks the full potential of the d&b system approach. In a typical user workflow, the d&b Remote Network takes settings optimized in the d&b ArrayCalc simulation software and applies these to all the amplifiers within the network.

All functions and controls available on the front panel of d&b amplifiers may be remotely controlled and/or monitored using the d&b R1 Remote control software. This allows each channel of the amplifier to be controlled and enables the creation of groups of loudspeakers. When grouped together, a button or fader can control the overall system level, zone level, equalization and delay, power ON/OFF, MUTE, as well as loudspeaker specific function switches such as CUT/HFA/HFC and CPL. An offline mode is provided for preparation in advance of an event, without the amplifiers being present or connected.

d&b System check verifies that the system performs within a predefined condition, while the Array verification function automatically identifies the physical position of a loudspeaker in an array to check that the system is cabled correctly. Extensive facilities for storing and recalling system settings are provided allowing these to be repeated, as and when required. For mobile applications, project files can be easily adjusted for use with a different set of equipment at another location.

In installation projects the R90 touchscreen remote control can be used for quick and reliable operation of day-to-day functions of a pre-configured d&b system without needing expert level knowledge of audio. The built-in 7" panel PC provides users with one-touch control over power, mute, level, grouping and recall of up to nine AmpPresets, entirely independent of R1.

The R1 software is optimized for use with touch screen, mouse and keyboard and runs on both Microsoft Windows¹ (Win7 64-bit or later) and Mac OS X² (10.12 or later).

Further information is provided in the d&b Amplifier and Software brochure which is available for download at www.dbaudio.com.



Home



Remote in Configuration mode



16-band equalizer

¹ Microsoft Windows is a registered trademark or trademark of Microsoft Corporation in the United States and/or other countries

² Mac OS X is a trademark of Apple Inc., registered in the U.S. and other countries

The d&b amplifiers

The d&b amplifiers are designed specifically to power d&b loudspeakers and are the beating heart of the d&b System reality. As such, they incorporate Digital Signal Processing for comprehensive loudspeaker management, switchable filter functions, remote capabilities and user-definable controls, to fulfil the exact needs of each application. Every loudspeaker configuration combines comprehensive system limiting, and equalization and crossover settings to ensure consistent results and optimal performance. d&b amplifiers offer

different output configurations for different loudspeaker setups, including Dual Channel mode, for passive setups, Mix TOP/SUB mode, in which two channels are driven through a single output connector, and 2-Way Active mode, which also sends the output of two channels down one connector to drive appropriate loudspeakers actively. The d&b switch functions provide selected filters to precisely tailor a wide variety of setups to their applications. Examples of these switch functions are the CSA (Cardioid Subwoofer Array)

and HFC (High Frequency Compensation) modes. CSA increases low frequency directivity control by minimising energy transmission towards the rear while HFC compensates for air absorption for loudspeakers covering far field listening positions. In addition to these functions, d&b amplifiers offer a comprehensive set of specific filters such as CUT, a cut mode for TOP loudspeakers when used with d&b subwoofers; CPL, to compensate for the coupling effect between loudspeakers in close proximity to other loudspeakers or hard objects and HFA

mode, to attenuate the high frequencies of a loudspeaker to mimic the effect of far field listening. These devices offer extended, user-definable equalization and delay capabilities, eliminating the need for external processing devices in the signal chain. All d&b amplifiers integrate with the d&b Remote network to enable the remote control and management of systems from anywhere within a network. Further information is provided in the d&b Amplifier and Software brochure which is available for download at www.dbaudio.com.

Comparison of the d&b amplifiers

	D80	30D
User interface	Encoder/colour TFT touchscreen	LED indicators
Output channels	4	4
Input channels	4 x AES3 or 4 x analog or 2 x AES3 and 2 x analog	4 x AES3 and 4 x analog
Latency	0.3 msec	0.3 msec
User equalizers (per channel)	2 x 16-band	2 x 16-band
Delay	10 sec/3440 m	10 sec/3440 m
Maximum output power (THD+N < 0.5%, 12 dB crest factor)	4 x 2000 W into 8 ohms 4 x 4000 W into 4 ohms	4 x 800 W into 8 ohms 4 x 1600 W into 4 ohms
Output routing	Dual Channel, Mix TOP/SUB 2-Way Active	Dual Channel, Mix TOP/SUB 2-Way Active
Output connectors	NL4/EP5 plus central NL8	Phoenix Euroblock
GPIO connector, 5 ports	No	Phoenix Euroblock
Cable compensation	LoadMatch	LoadMatch
Power supply	Autosensing switched mode power supply with active PFC	Universal range switched mode power supply with active PFC
Mains voltage	100 - 127/208 - 240 V, 50 - 60 Hz	100 - 240 V, 50 - 60 Hz
Weight (kg/lb)	19/42	10.6/23.4
Dimensions	2 RU x 19" x 530 mm	2 RU x 19" x 435 mm
Remote	OCA via Ethernet/CAN	OCA via Ethernet/CAN

Airflow

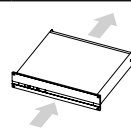
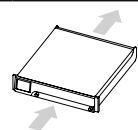

The controller setups and operation with d&b amplifiers

Arc and Line mode

The Arc mode is used for line array loudspeakers when used in curved array sections with splay angles between 2° and 7°. The Line mode is used for long throw array sections with three or more consecutive splay settings between 0° and 1°. Compared to the Arc mode, the upper mid range is reduced to compensate for the extended near field.

AP setup

In connection with ArrayProcessing (AP), the AP setup contains the AP data that are generated in the ArrayCalc simulation software. These are transferred to the applicable amplifiers via the d&b Remote network (OCA/AES70) using R1.

CUT mode

Set to CUT, the cabinet low frequency level is reduced and it is now configured for use with the d&b J subwoofer.

HFC mode

Selecting the HFC (High Frequency Compensation) mode compensates for loss of high frequency energy due to absorption in air when loudspeakers are used to cover far field listening positions. HFC has two settings which should be used selectively, HFC1 for cabinets covering distances larger than 40 m (130 ft) and HFC2 for those covering distances larger than 80 m (260 ft). This can be used to achieve the correct sound balance between close and remote audience areas allowing all amplifiers driving the array to be fed from the same signal source.

CPL function

The CPL (Coupling) function compensates for coupling effects between closely coupled cabinets by reducing the low and mid frequency level. CPL begins gradually at 2 kHz, with the maximum attenuation below 100 Hz, providing a balanced frequency response when J-Series cabinets are used in arrays of five or more.

INFRA mode

Selecting the INFRA mode restricts the J-SUB frequency response to a narrow 32 Hz - 70 Hz range. The J-SUB can now be used to supplement d&b J-Series systems operated in full range mode.

HCD mode

Depending on the application requirements, the dispersion pattern of the J-SUB and J-INFRA cabinets can be modified electronically to achieve the best sound rejection where it is most effective. In standard cardioid mode the amplifier J-SUB and J-INFRA setup provides the maximum rejection directly behind the cabinet,

whilst selecting HCD (hypercardioid) optimizes the tuning for a maximum rejection to the rear left and right sides. The HCD mode is particularly useful for applications with subwoofers stacked on the left and right sides of the stage to provide the minimum low frequency energy onstage.

70 Hz mode

Selecting the 70 Hz mode extends the J-INFRA frequency response to a 27 Hz - 70 Hz range. The J-INFRA can now be used to supplement d&b J-Series systems operated in full range mode.

Recommended amplifiers for mobile applications

	J8	J12	J-SUB	J-INFRA
D80	x	x	x	x

Recommended amplifiers for installation applications

	J8	J12	J-SUB	J-INFRA
D80	x	x	x	x
30D	x	x	x	

Maximum loudspeakers per amplifier

	J8	J12	J-SUB	J-INFRA
D80	4	4	2	2
30D	4	4	2	2

Available controller settings

	J8	J12	J-SUB	J-INFRA
Arc/Line	x	x		
AP	x	x	x	x
CUT	x	x		
HFC	x	x		
CPL	x	x		
INFRA			x	
HCD			x	x
70 Hz				x

The J-Series frequency responses

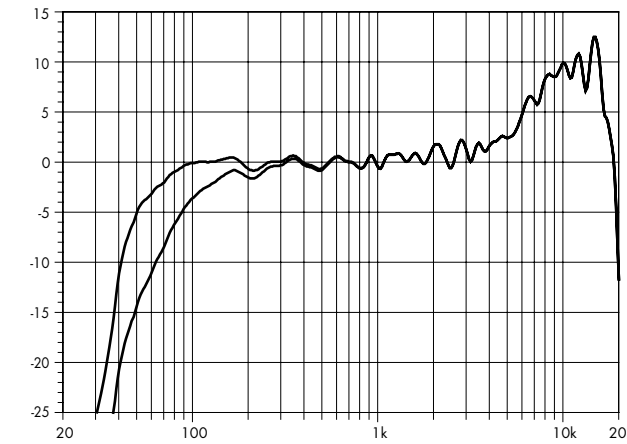

J8 standard and CUT (single cabinet)

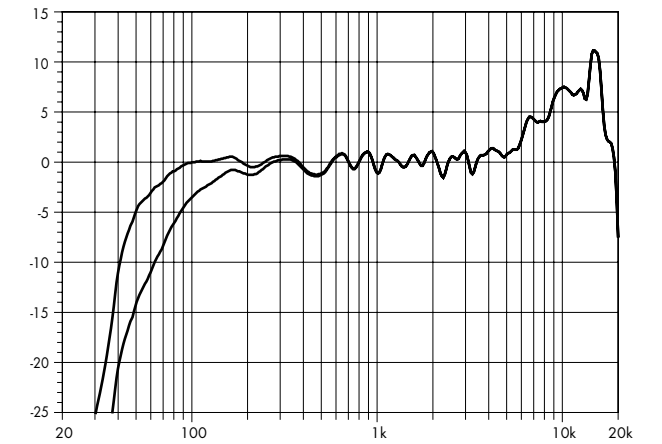

J12 standard and CUT (single cabinet)

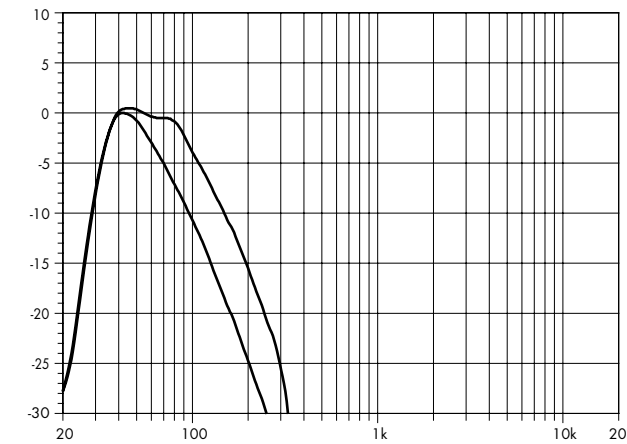

J-SUB standard and INFRA

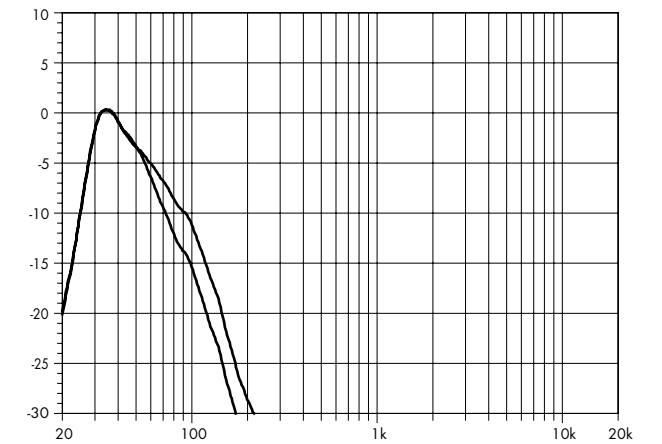

J-INFRA standard and 70 Hz

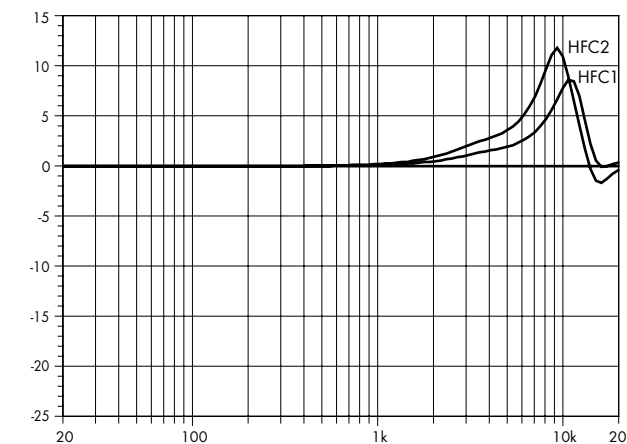

Correction of HFC*
*schematic diagram

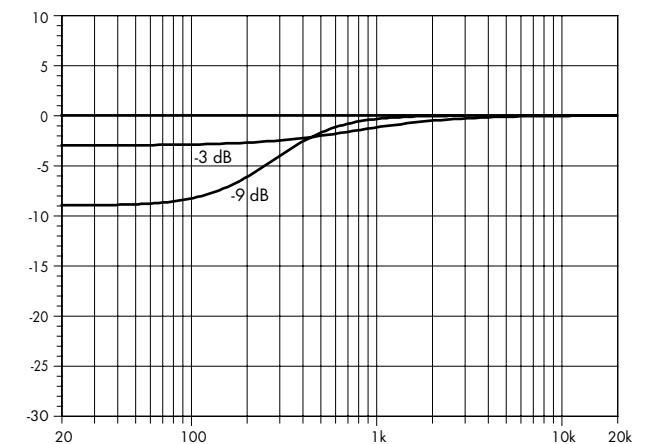

Correction of CPL*
*schematic diagram

The d&b amplifier output modes

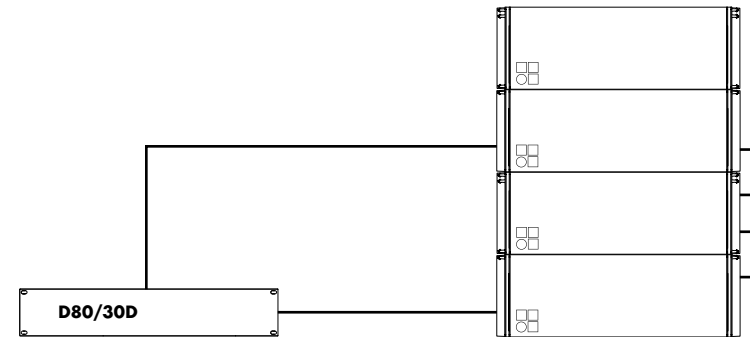

D80/30D amplifier in 2-Way Active mode for J8 and/or J12

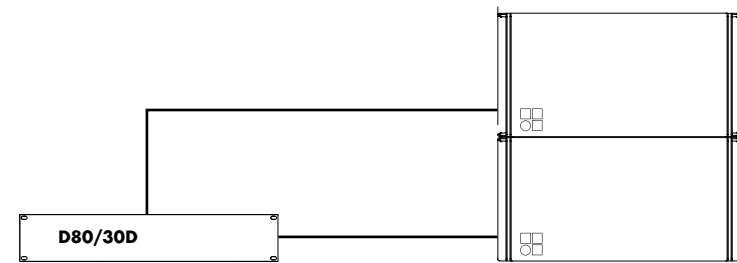

D80/30D amplifier in 2-Way Active mode for J-SUB and/or J-INFRA

The DS10 and DS20 Audio network bridges The DS100 Signal Engine

DS10 Audio network bridge

The DS10 Audio network bridge interfaces between Dante networks and AES3 digital audio signals, while also providing distribution of Ethernet control data. Positioned within the signal chain in front of the amplifiers, this 1 RU device expands the d&b system approach. Each unit can deliver up to sixteen Dante network channels via AES3 digital signal outputs. Additionally, four AES3 input channels provide access to the Dante audio network for applications such as a break-in from a Front of House console. The DS10 incorporates an integrated 5-port switch, offering a primary and redundant network for the Dante protocol, as well as advanced functions such as Multicast Filtering and VLAN modes. Using the DS10 Audio network bridge, audio signals and remote control data can be combined using a single Ethernet cable.



The DS10 Audio network bridge front view



The DS10 Audio network bridge rear view

DS20 Audio network bridge

The DS20 Audio network bridge supports the open standards-based Milan protocol rather than Dante. Milan (Media integrated local area networking) is a high level interoperability solution based on Audio Video Bridging (AVB) technology. The main advantages are deterministic behaviour (zero network congestion); improved reliability; optimum synchronization and hassle free network setup, as no special settings, such as QoS, need to be set within the switches to ensure delivery.



The DS20 Audio network bridge front view



The DS20 Audio network bridge rear view

DS100 Signal Engine

The d&b DS100 Signal Engine is the platform underneath the Soundscape, based on a specialized rack mount 3 RU audio processor with Audinate Dante networking. It provides a 64 x 64 audio matrix with level and delay adjustments at all cross points. Additional software modules provide dynamic source positioning and emulated acoustics functions. The DS100 is a versatile tool for use within complex audio systems to route and distribute multiple audio channels to numerous amplifiers driving loudspeaker positions and zones, show relay and break out rooms. The networking capabilities with a Dante enabled processor are significant, particularly for busy, multi-room complexes. The DS100 completely integrates with the overall d&b system approach, including loudspeakers, amplifiers, rigging, transport and networking accessories and the DS10 Audio network bridge. The complete system is designed and optimized in the d&b ArrayCalc simulation software, and controlled via the d&b R1 Remote control software.



The DS100 Signal Engine front view

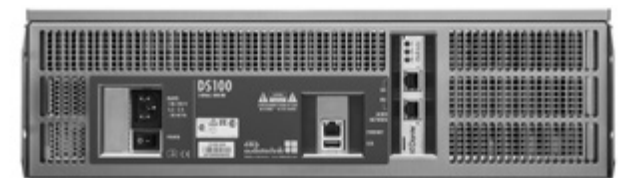

The DS100 Signal Engine rear view

The J-Series configuration examples

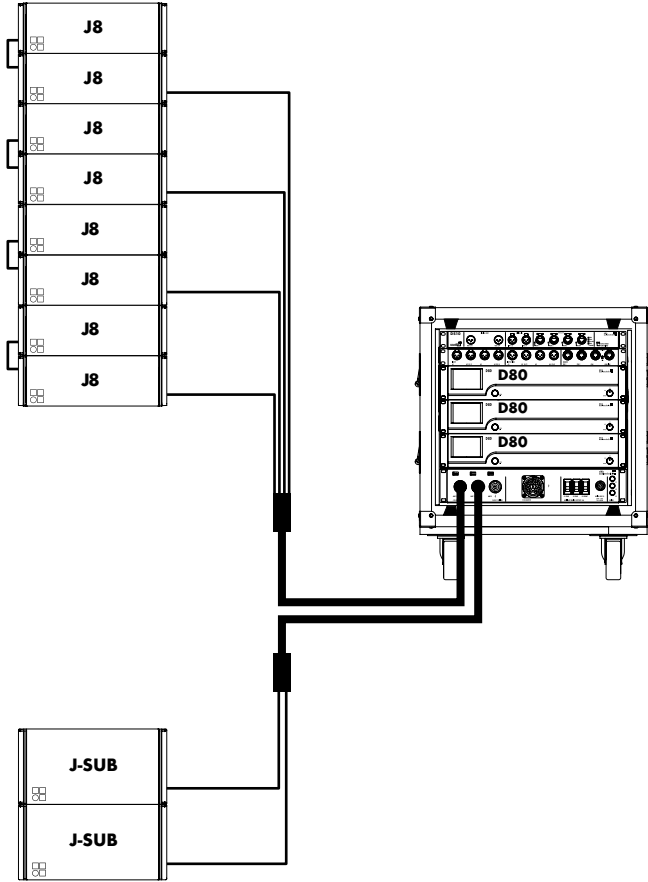

J-Series configuration with J8 flown line array and ground stacked J-SUBs with a D80 Touring rack

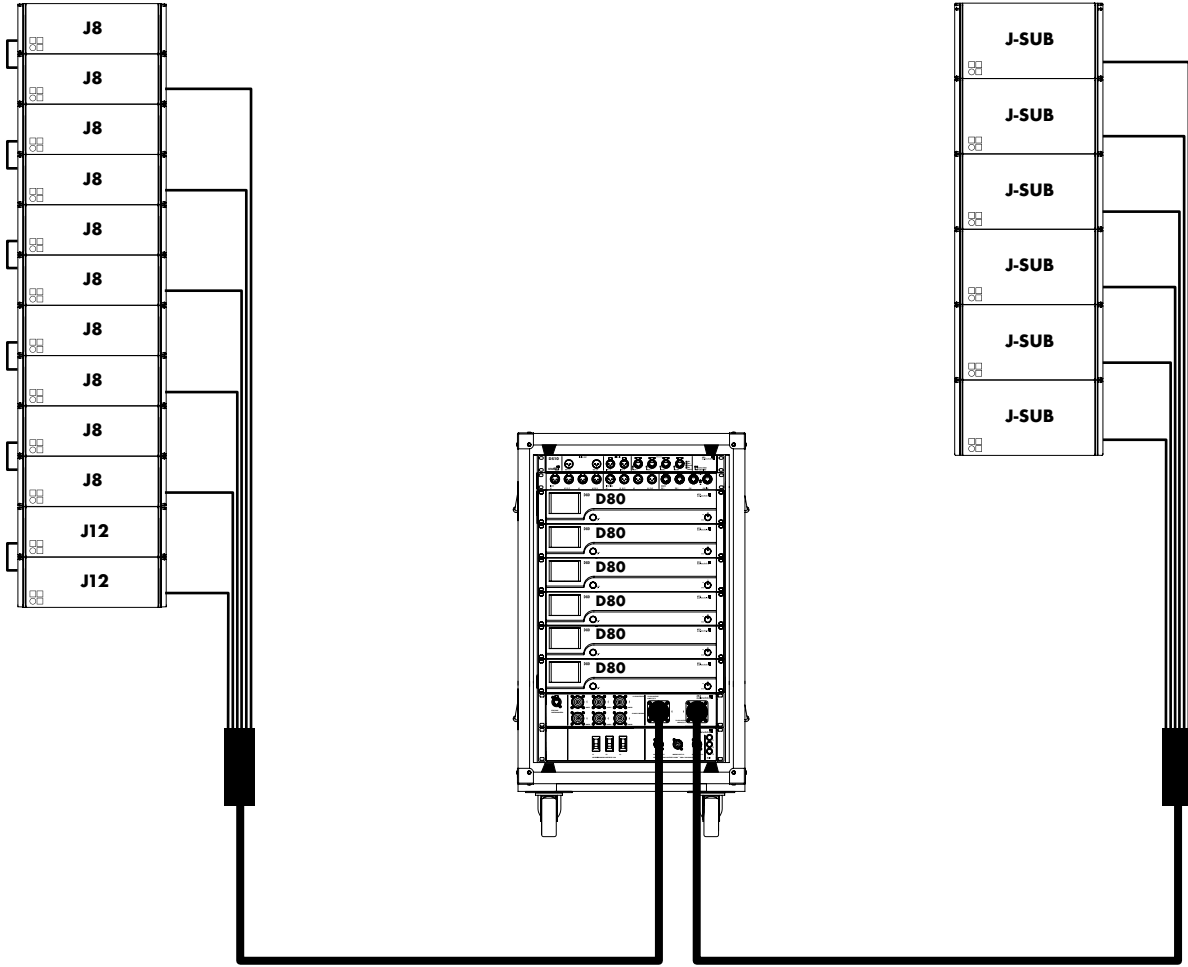

J-Series configuration comprising J8/J12 mains, a flown J-SUB column along with ground stacked J-SUBs and J-INFRAs and Y7Ps as nearfills with D80 Touring racks

The J-Series configuration examples

The J-Series configuration examples with ArrayProcessing

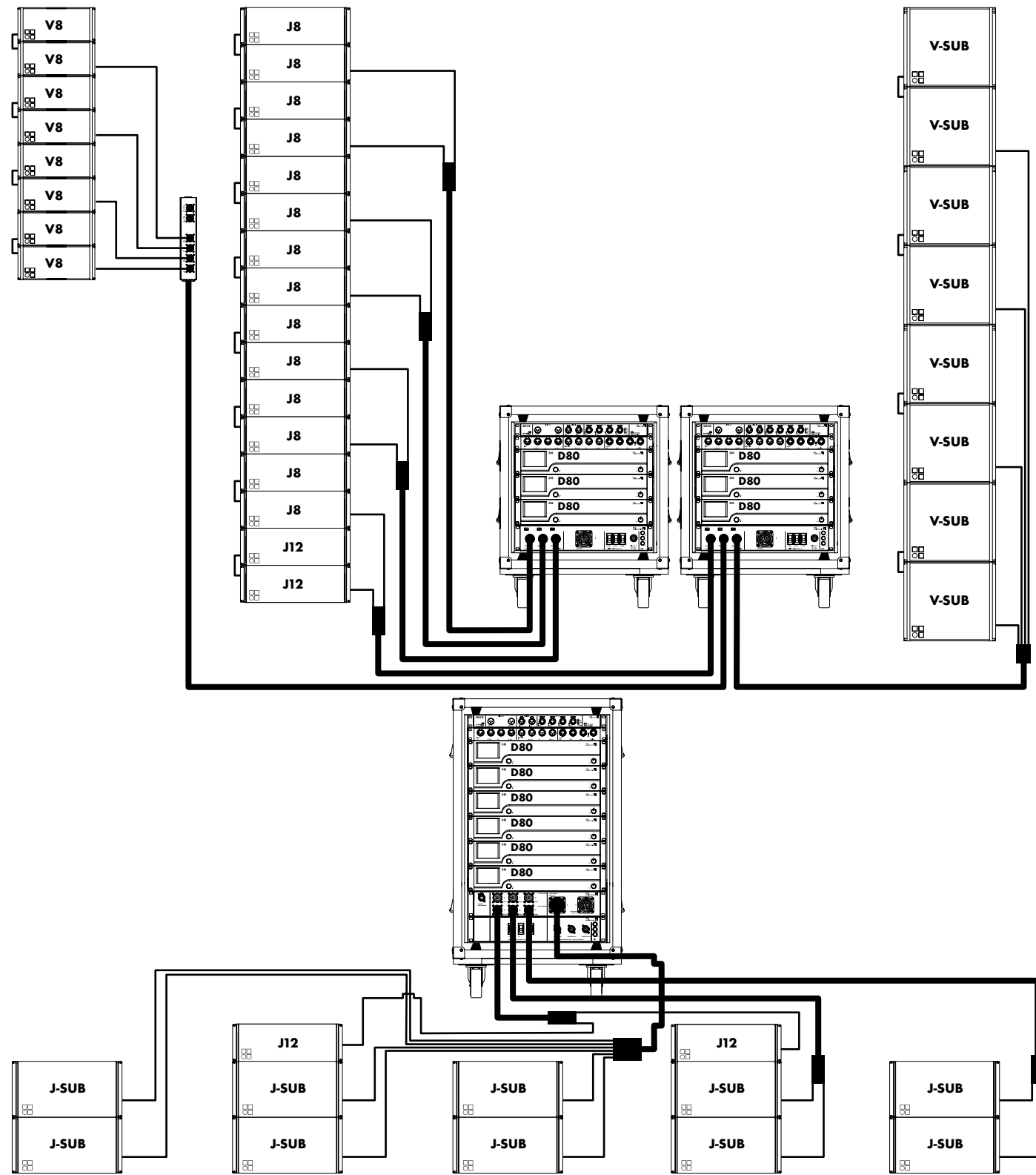

J-Series configuration comprising J8/J12 mains and V8 outfill arrays along with ground stacked J-SUBs with D80 Touring racks and a single D80 amplifier

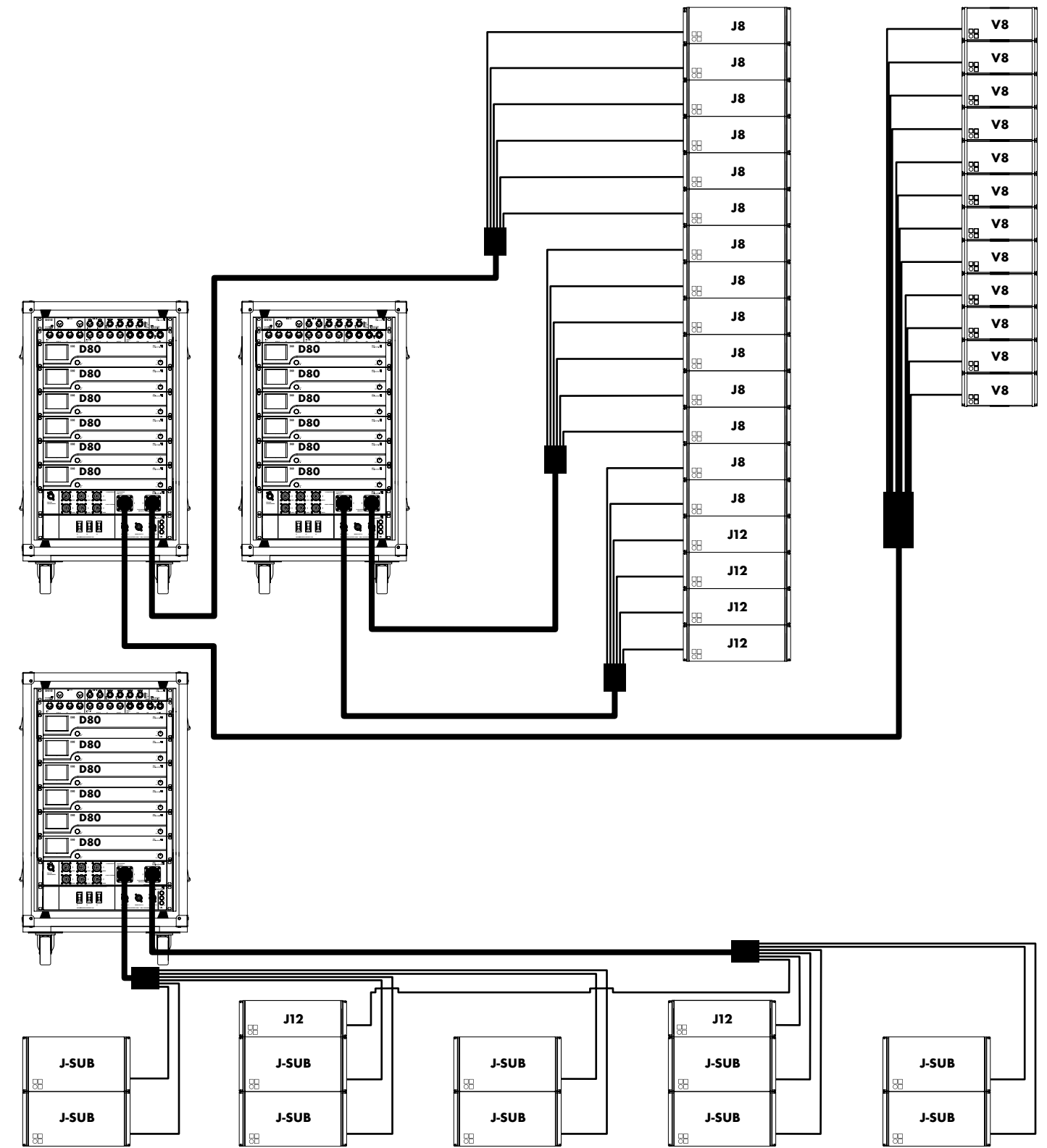

J-Series configuration comprising J8/J12 mains and V8 outfill arrays driven with ArrayProcessing along with ground stacked J-SUBs with D80 Touring racks and a single D80 amplifier

The J-Series cables and adapters MC8 / MC24

Amplifiers in 2-Way Active mode

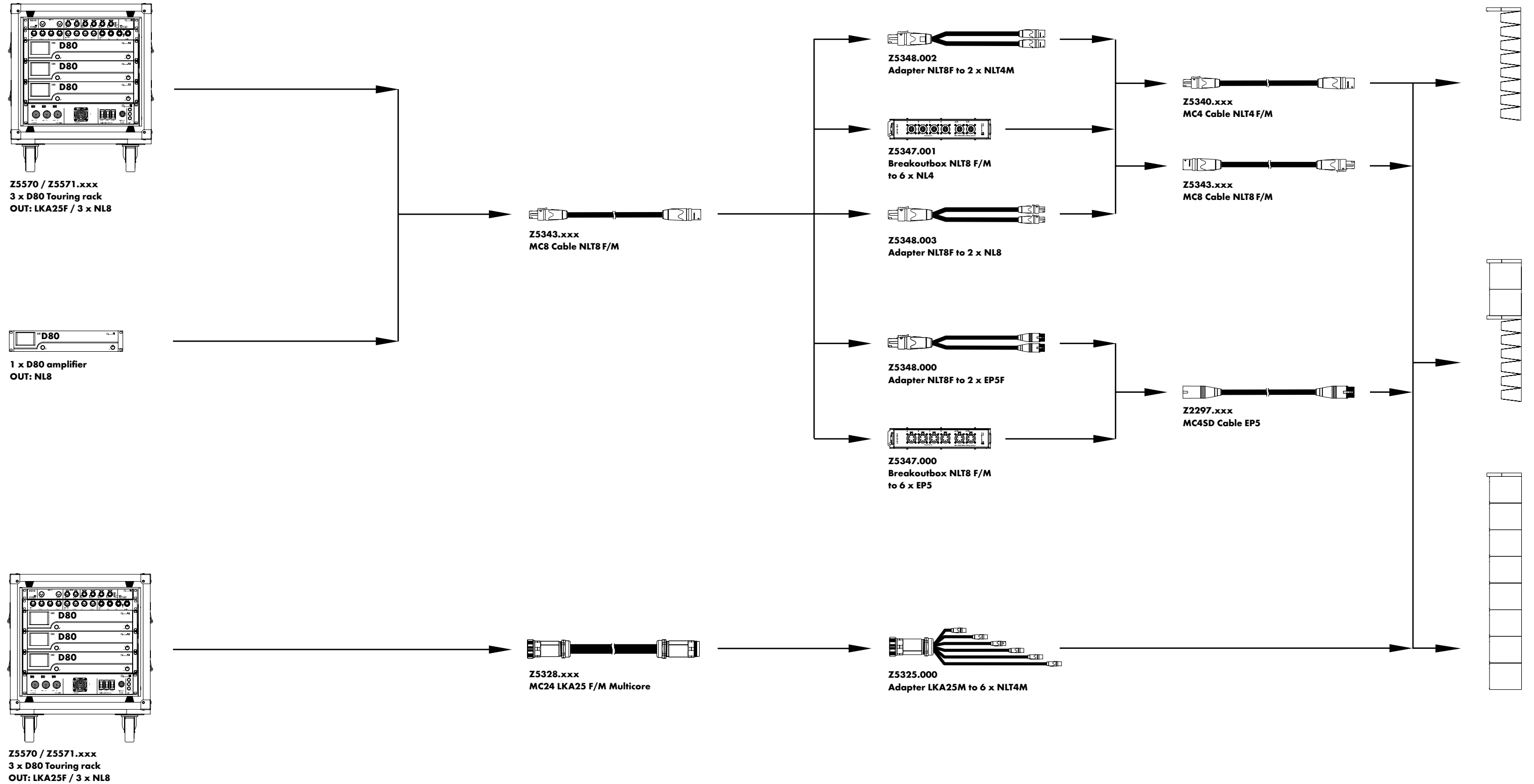

The J-Series cables and adapters MC8 / MC24

Amplifiers in 2-Way Active mode

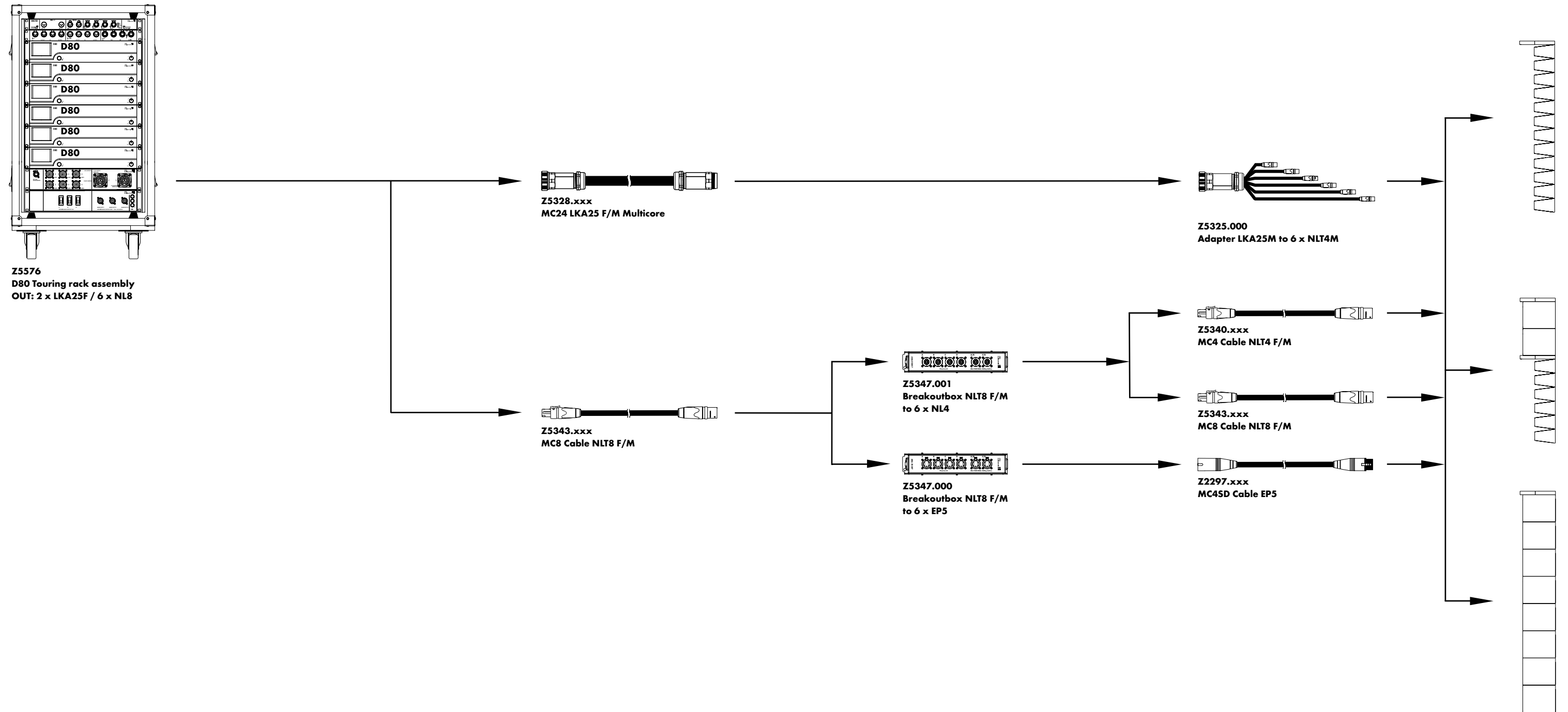

The J-Series product overview

CPO Products	AZ0650.002.1	J8 CPO Loudspeaker NLT4F/M	Amplifier rack assemblies	Z5570.xxx	3 x D80 Touring rack ³	
	AZ0651.002.1	J12 CPO Loudspeaker NLT4F/M		Z5571.xxx		3 x D80 Touring rack (includes DS10) ³
	AZ0660.002.1	J Subwoofer CPO NLT4F/M		Z5576.xxx		6 x D80 Touring rack (includes DS10) ³
	AZ1000.002.1	J-INFRA CPO Subwoofer		Racks	E7468.000	D80 Touring rack 2 RU, 19" SD , shock mounted, handles
	AE7919.000.1	J Wheelboard CPO			E7483.000	
	AE7910.000.1	J-SUB CPO Wooden lid			Cables and adapters	Z5340.xxx
	AE7920.000.1	J-INFRA CPO Wooden lid		Z5343.xxx		MC8 Cable NLT8 F/M
	AZ5300.001.1	J Flying frame CPO with touring case		Z5348.000		Adapter NLT8F to 2 x EP5F
	AZ5305.000.1	J Hoist connector chain CPO		Z5345.001		Adapter 4 x NL4 to NLT8M
Loudspeakers	Z0650.002	J8 loudspeaker NLT4 F/M connector	Z5348.002	Adapter NLT8F to 2 x NLT4M		
	Z0650.000	J8 loudspeaker EP5 connector	Z5347.000	Breakoutbox NLT8 F/M to 6 x EP5		
	Z0650.010	J8 loudspeaker NL8 connector	Z5347.001	Breakoutbox NLT8 F/M to 6 x NL4		
	Z0651.002	J12 loudspeaker NLT4 F/M connector	Z5348.003	Adapter NLT8F to 2 x NL8		
	Z0651.000	J12 loudspeaker EP5 connector	Z2297.xxx	MC4SD Cable EP5		
	Z0651.010	J12 loudspeaker NL8 connector	Z5328.xxx	MC24 LKA 25 F/M Multicore		
	Z0660.002	J subwoofer NLT4 F connector	Z5325.000	Adapter LKA25M to 6 x NLT4M		
	Z0660.000	J subwoofer EP5 connector	Alignment tools	Z5710.001	d&b ArraySight set J Series	
	Z0660.010	J subwoofer NL8 connector		Z5762.000	d&b ArraySight meter unit	
	Z1000.002	J-INFRA subwoofer NLT4 F connector				
	Z1000.000	J-INFRA subwoofer EP5 connector				
	Z1000.010	J-INFRA subwoofer NL8 connector				
Cases	E7441.000	Touring case 1 x J Flying frame				
Lids	E7919.000	J Wheelboard				
	E7910.000	J-SUB Wooden lid				
	E7920.000	J-INFRA Wooden lid				
Accessories	Z5300.000	J Flying frame (supplied with Z5303 J Safety chainset)				
	Z5303.000	J Safety chainset				
	Z5305.000	J Hoist connector chain				
Amplifiers	Z2710.xxx	D80 amplifier ¹				
	Z2770.xxx	30D amplifier ²				
Processing and distribution	Z4010.000	DS10 Audio network bridge				
	Z4011.000	DS20 Audio network bridge				
	Z4100.000	DS100 Signal Engine				

¹ The complete list of mobile amplifier versions is available in the D Amplifier and Software brochure

² The complete list of installation amplifier versions is available in the xD Installation Amplifier and Software brochure

³ Further information is available in the d&b D Amplifier and Software brochure

